



KCM-5211E

**18x Zoom H.264 4-Megapixel IP IR D/N
PoE Outdoor Box Camera**

Hardware User's Manual

(DC 12V / PoE)

Ver. 2012/3/5



ACTi
Connecting Vision

Table of Contents

0. Precautions	3
1. Introduction	4
Package Contents	4
Features and Benefits	5
Safety Instructions	6
Physical description	8
Preparing for Installation	11
How to Do the Waterproof Installation	11
Basic Connections	15
Product Specification	16
2. Accessing Camera	18
If you have DHCP server / router in your network:	18
If you do <i>NOT</i> have DHCP server / router in your network:	18

0. Precautions

Read these instructions

You should read all the safety and operating instructions before using this product.

Heed all warnings

You must adhere to all the warnings on the product and in the instruction manual. Failure to follow the safety instruction given may directly endanger people, cause damage to the system or to other equipment.

Servicing

Do not attempt to service this video device yourself as opening or removing covers may expose you to dangerous voltage or other hazards. Refer all servicing to qualified service personnel.

Trademarks

All names used in this manual are probably registered trademarks of respective companies.

Liability

Every reasonable care has been taken during the writing of this manual. Please inform your local office if you find any inaccuracies or omissions. We cannot be held responsible for any typographical or technical errors and reserve the right to make changes to the product and manuals without prior notice.

FCC/CE Regulation

NOTE: This equipment has been tested and found to comply with the limits for a Class A digital device, pursuant to Part 15 of the FCC Rules. These limits are designed to provide reasonable protection against harmful interference when the equipment is operated in a commercial environment. This equipment generates, uses, and can radiate radio frequency energy and, if not installed and used in accordance with the instruction manual, may cause harmful interference to radio communications. Operation of this equipment in a residential area is likely to cause harmful interference in which case the users will be required to correct the interference at their own expense.

1. Introduction

Package Contents

KCM-5211E



Product CD



Terminal Blocks for Power, DI/O and Serial Port

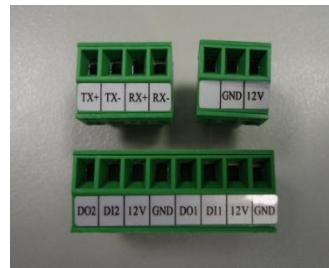

Warranty Card



Features and Benefits

This is a cutting edge network video surveillance camera. It can capture, compress and transmit real time video in excellent quality (8 FPS 4Megapixel, 2032 x 1920). This camera is your best choice to build an intelligent IP surveillance system.

18x Zoom Lens with Auto Focus

The powerful 18x Zoom Lens with ISP enabled Auto Focus brings precision video quality not available with manual adjustments. Focus is no longer an issue during installation, saving time while enhancing quality.

Adaptive Profile

With the innovative embedded Image Signal Processor (ISP), this camera responds to changing lighting condition with customized algorithm. This allows for clear image with very little noise at night.

H.264/MPEG-4/MJPEG Triple Codec Dual Streaming

This device supports 3 compression formats, H.264, MPEG-4 and MJPEG. It brings superior image quality at 8 frames per second up to resolution of 2032 x 1920 pixels, and offers up to 15 frames per second in Full HD 1080p (1920 x 1080). In 720p (1280 x 720) and VGA resolution (640 x 480) the device reaches 30 frames per second.

Up to 4 Cropped regions as independent Channels

This camera can capture 4 separate view windows with VGA resolution, and stream all 4 over the network. This means one camera can take the work of 4.

SDR (Superior Dynamic Range)

This IP camera includes a special process that enhances the view in the brightest and darkest areas. This provides for more evenly illuminated image and brings out greater details to the eye.

DC Iris Control

With DC Iris Lens, this camera automatically adjusts incoming light levels to achieve the best video performance. Wildly fluctuating outdoor lighting condition is no longer an issue with your video quality.

Powerful Bundled Surveillance Software

To extend the capabilities of the IP Box Camera series, a powerful surveillance program is included in the package for free. Users can easily use an existing PC as a digital video recorder. Scheduled recording and manual recording keep every important video recorded in the local hard disk. Reliable and accurate motion detection with instant warning enables immediate response in every condition. Quick and simple search and playback function lets you easily find the images and video you want.

Software Development Kit Support

This IP Box Camera can be integrated or controlled by applications from third party software developers. Software developers can save considerable efforts by using our Streaming Library or ActiveX control.

Safety Instructions

Don't use the power supply with other voltages

This device is likely to be damaged or damage other equipments / personnel, if you use a power supply with different voltage than the one included with this device. All warranty of this product will be voided in the situations above.

Don't open the housing of the product

Cleaning

Disconnect this video product from the power supply before cleaning.

Attachments

Do not use attachments not recommended by the video product manufacturer as they may cause hazards.

Water and Moisture

Do not use this video product near water, for example, near a bathtub, washbowl, kitchen sink, or laundry tub, in a wet basement, or near a swimming pool and the like.

Don't use accessories not recommended by the manufacturer

Only install this device and the power supply in a dry place protected from weather

Servicing

Do not attempt to service this video product yourself as opening or removing covers may expose you to dangerous voltage or other hazards. Refer all servicing to qualified service personnel.

Damage Requiring service

Disconnect this video product from the power supply immediately and refer servicing to qualified service personnel under the following conditions.

- 1) When the power-supply cord or plug is damaged
- 2) If liquid has been spilled, or objects have fallen into the video product.
- 3) If the video product has been directly exposed to rain or water.
- 4) If the video product does not operate normally by following the operating Instructions in this manual. Adjust only those controls that are covered by the instruction manual, as an improper adjustment of other controls may result in damage, and will often require extensive work by a qualified technician to restore the video product to its normal operation.

Safety Check

Upon completion of any service or repairs to this video product, ask the service technician to perform safety checks to determine if the video product is in proper operating condition.

Physical description



- | | |
|-----------------------------------|--------------------------|
| ① Micro SD / Micro SDHC Card Slot | ⑤ Serial Port Input |
| ② Power LED | ⑥ Reset Button |
| ③ Audio Input / Output | ⑦ Ethernet Port |
| ④ DC 12V Power Input | ⑧ Digital Input / Output |

1) Micro SD / Micro SDHC Card Slot*

Insert your Micro SD card here for local recording on camera

2) Power LED

This LED light will indicate current camera status.

3) Audio Input / Output

The IP device supports audio input and output with earphone jack

4) Power Input

If you use Power Adaptor to run the device, please connect the power adaptor to the terminal block in the way shown below.



5) Serial Port

This port connects to serial devices via RS-485 or RS-232 protocols.

Pin Number	RS422	RS485
1	TX+	D+
2	TX-	D-
3	RX+	N.C.
4	RX-	N.C,

6) Reset Button

Step 1: Switch off IP device by disconnecting the power cable

Step 2: Press and continue to hold the Reset Button (with a sharp tipped object, like a pen.)

Step 3: **Reconnect the power cable while continuing to hold the reset button.** The red Power LED light will flash on for 3 second first, turn off for about 15 seconds, flash on for another second and turn off again. By this time the reset to default operation is already completed. **This will take around 20 seconds from power up.** You may then release the reset button. This length of time fluctuates slightly with the environment. The Power LED light will come back on and stay on after a few more seconds. The unit will start up with factory default settings automatically.

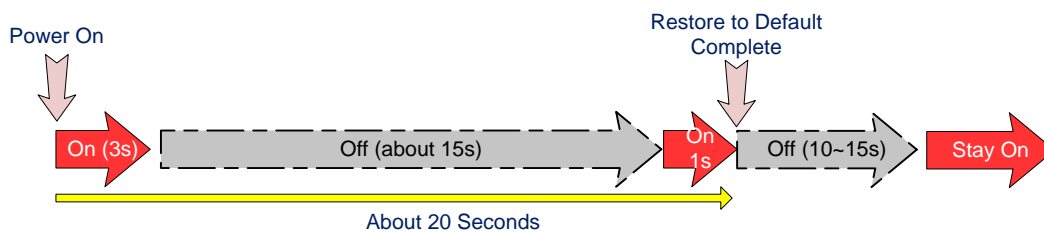

7) Ethernet Port

The IP device connects to the Ethernet via a standard RJ45 connector. Supporting NWAY, this IP device can auto detect the speed of local network segment (10Base-T/100Base-TX Ethernet).

8) Digital Input / Output

Used in applications like motion detection, event triggering, time lapse recording, alarm notifications, etc., the I/O terminal connector provides the interface to:

• **1 Transistor Outputs** - For connecting external devices such as relays and LEDs. Connected devices can be activated by Output buttons on the Live View page or through video management software. Connect DO1 and DO2 to their closest 12V pin to activate.



• **2 Digital Inputs** - An alarm input for connecting devices that can toggle between an open and closed circuit, for example: PIRs, door/window contacts, glass break detectors, etc. The device will detect the change in digital input and transmit the signal to video surveillance servers. The I/O terminal pins are numbered right to left,

Connect input/output devices to the camera as follows:

1. Attach the cables for the device securely to the supplied green connector block. **Connect DI pins to GND pins, and DO pins to 12V pins. Link pins 1/3, 2/4, 5/7,6/8.**
2. Once cables are connected, push connector block into the terminal connector on camera.

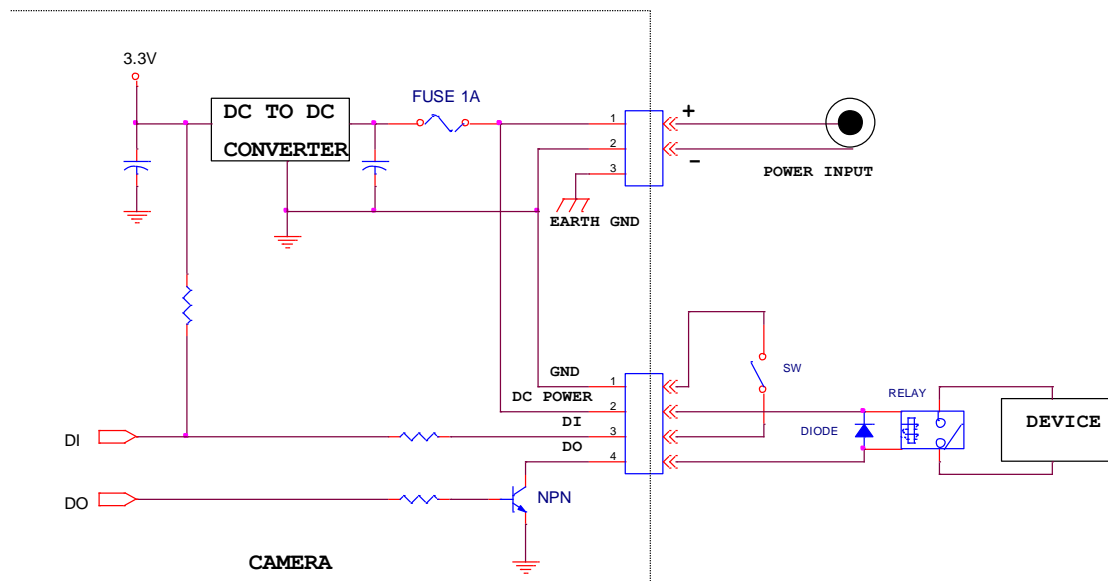

Preparing for Installation

Remove the back cover by unscrewing the four attachments.



How to Do the Waterproof Installation

The following installation procedure makes the camera be water-resistant even for the situations where the camera can easily be flooded by pouring rain.

The important part to focus on during the installation:

The protection of the cabling has to be done by a proper flex conduit. The size of the flex conduit that matches with the conduit gland is **3/8"**. (Not included in the package)



The following images show the step-by-step procedure of completing the water-proof installation.



1. Disassemble the conduit gland as shown on the photo.
2. Pull the network cable through the flex conduit. Please note that the size of the conduit and the gland is big enough to let the RJ-45 connector pass through all the way.



3. Two pieces from the conduit gland set will be attached to flex conduit first.



4. The third piece goes through the back side cover of the camera.



5. The fourth piece (locking nut) is used to lock the gland firmly from the inside of the back side cover.



6. Pull the network cable through the back side cover of the camera.



7. Connect the flex conduit to the back side cover of the camera.



8. Tighten the domed sealing nut.



9. Plug the network cable into the camera's RJ-45 connector before closing the back side of the camera. If you are not using PoE and need an additional power cord then please connect it at this stage, too.



10. Tighten the screws of the back side of the camera properly.



11. Finally, the box camera with properly mounted flex conduit as well as with proper outdoor bracket would look like this.

Basic Connections

Follow the procedures below to connect the IP device to the respective apparatuses.

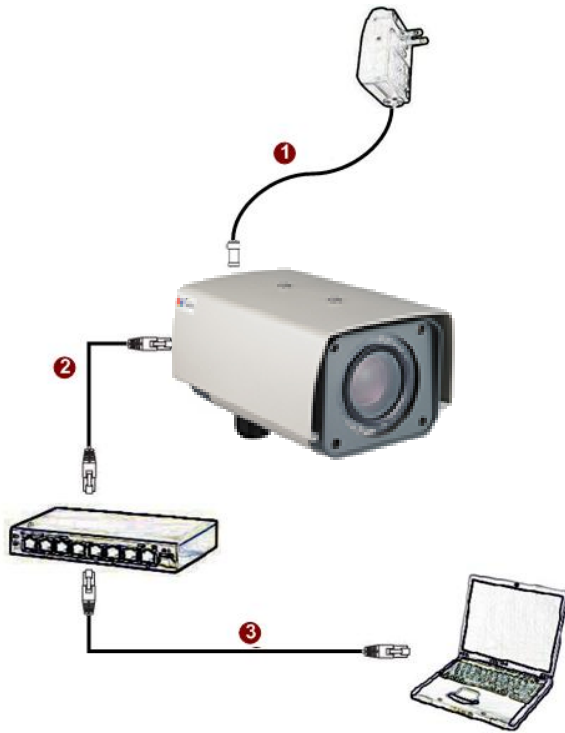

If you have a PoE (Power over Ethernet) supported switch or injector:

- 1) Connect your IP Box Camera to the Switch / Injector by CAT5 or CAT6 cables with RJ45 connector.
- 2) Connect your Switch / Injector to PC with another CAT5 / CAT6 network cable.

If your switch does not support PoE, and you are powering the camera with power adaptor:

- 1) Connect the power adaptor to IP Box Camera
 - 2) Connect IP device's Ethernet port to Network switch (via RJ45 connectors).
- Connect a PC to the Ethernet switch (via RJ45 connectors)

Please refer to our [PoE Guide](#) for more details on Power over Ethernet related concepts.

Product Specification

KCM-5211E	
• Device	
Device Type	Box Camera
Image Sensor	Progressive Scan CMOS
Sensor Size	1/3.2" (4.5 x 3.4 mm)
Horizontal Resolution	1650 TVL
Day / Night	Yes
Minimum Illumination	Color: 0.1 lux at F1.6 (30 IRE, 2400°K); B/W: 0 lux (IR LED on)
Color to B/W switch	ISP based switch, configurable
Mechanical IR Cut Filter	Yes
IR Sensitivity Range	700 - 1100 nm
IR LED	IR LED x 24 (850 nm)
Electronic Shutter	1/25 - 1/2000 sec (50Hz); 1/15 - 1/2000 sec (60Hz) (manual mode) 1 - 1/2000 sec (auto mode)
• Lens	
Focal Length	Zoom, f4.7 - 84.6 mm / F1.6 - F2.8
Zoom Ratio	18x optical
Zoom Speed	2.63 sec (1x to 18x)
Iris	DC Iris
Focus	Auto Focus
Horizontal Viewing Angle	48.94° - 3.61°
• Video	
Compression	H.264, MPEG-4 SP, MJPEG
Maximum Frame Rate vs. Resolution (H.264, MJPEG)	8 fps at 2032 X 1920; 15 fps at 1920 X 1080 (HD 1080p); 30 fps at 1280 x 720 (HD 720p); 30 fps at 640 x 480 (VGA)
Maximum Frame Rate vs. Resolution (MPEG-4 SP)	5 fps at 2032 X 1920; 10 fps at 1920 X 1080 (HD 1080p); 24 fps at 1280 x 720 (HD 720p); 30 fps at 640 x 480 (VGA)
4 Cropped VGA Mode (All Compressions)	15 fps at 640 x 480 (VGA)
Multi-Streaming	Simultaneous dual streams based on two configurations in single view mode; Multiple streams based on single configuration in 4 cropped VGA mode
Bit Rate	28 Kbps - 6 Mbps (per stream)
Bit Rate Mode	Constant, Variable
S/N Ratio	More than 63.2 dB
Image Enhancement	SDR(Superior Dynamic Range); White balance: automatic, hold and manual; Brightness; Contrast; Automatic gain control; 2D+3D Digital noise reduction; Flickerless, Defogging
Privacy Mask	4 configurable regions
Text Overlay	User defined text on video
Image Orientation	Image flip and mirror
• Audio	
Compression	8 kHz, Mono, PCM, 16 bit encoding
Audio-In	3.5mm Phone Jack
Audio-Out	3.5mm Phone Jack

• Network	
Protocol & Service	TCP, UDP, HTTP, HTTPS, DHCP, PPPoE, RTP, RTSP, IPv6, DNS, DDNS, NTP, ICMP, ARP, IGMP, SMTP, FTP, UPnP, SNMP, Bonjour, Pelco-D
Ethernet Port	1, Ethernet (10/100 Base-T), RJ-45 connector
Security	IP address filtering; HTTPS encryption; Password protected user levels; IEEE 802.1X network access control
• Alarm	
Alarm Trigger	Video motion detection 3 regions in single view mode, 1 region each in 4 cropped VGA mode; External device through digital input
Alarm Response	Notify control center; Go to Zoom preset point or preset tour; Change camera settings; Command other devices; E-mail notification with snapshots; Save video or snapshot to local storage; Upload video, snapshot to FTP server; Activate external device through digital output
• Interface	
Digital Input	2, terminal block
Digital Output	2, terminal block
Serial Port	RS-485, RS-422, terminal block
Local Storage	MicroSD/SDHC memory card slot (card not included)
• General	
Power Source / Consumption	PoE Class 3 (IEEE802.3af) / 9.12 W (IR on) DC 12V / 11.52 W (IR on)
Weight	1350 g (2.98 lb)
Dimensions (W x H x D)	115.20 mm x 130.59 mm x 195.00 mm (4.50" x 5.10" x 7.70")
Operating Temperature	-30°C ~ 50°C (-22°F ~ 122°F)
Operating Humidity	10% ~ 85% RH
Approvals	Camera: CE, FCC, IP66; Adapter: CE, TUV-GS, UL, RCM, CCC
• Integration	
Unified Solution	Fully compatible with ACTi software
ISV Integration	Software Development Kit (SDK) available
Firmware Access Browser	Microsoft Internet Explorer 6.0 or newer

2. Accessing Camera

If you have DHCP server / router in your network:

Many network server / routers are able to automatically provide IP addresses through DHCP. If you are using such a network, just plug in your computer and IP Box Cam into the network and your IP device will acquire network address by itself. Find and access the device with our IP Utility program. You may download it at:

http://www.acti.com/product/detail/Software/ACTi_Utility_Suite

If you do ***NOT*** have DHCP server / router in your network:

1. Configure your PC to use the same subnet by changing your PC's IP address to the subnet with prefix 192.168.0.XXX. The last number should be anything from 1 to 254 except 100 and other occupied IP addresses. Subnet mask should be 255.255.255.0.
2. **The default IP used by this device is 192.168.0.100. Please make sure your PC is NOT using this address and that no two equipments use the same IP address in the network.**
3. Change your IP address by going to Control Panel ->Manage Network Connections -> Right click on the connection to change -> Option -> TCP/IP IPv4 Properties.

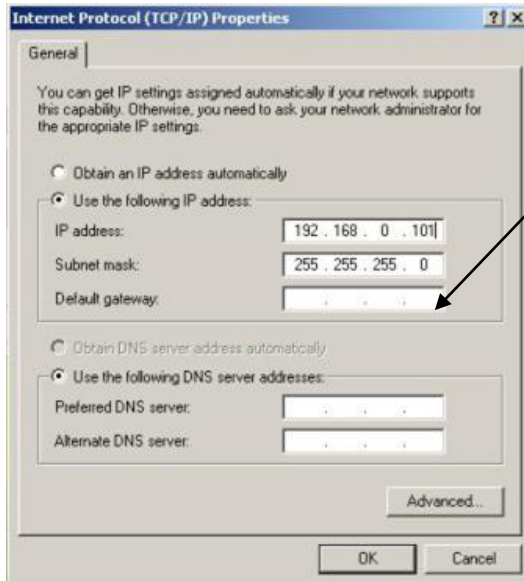

Please set the settings as below.

-
- IP address: 192.168.0.xxx
- Subnet mask: 255.255.255.0

(NOTE: xxx should be a number from 1 to 254 except 100, which is used by the IP device. Please also make sure that no two equipments use the same IP address in the

4. Open Internet Explorer (Version 6.0 or above) , and type in the Default IP:

192.168.0.100

5. When you see the login window, please input default user and password:

Default User: Admin Password: 123456

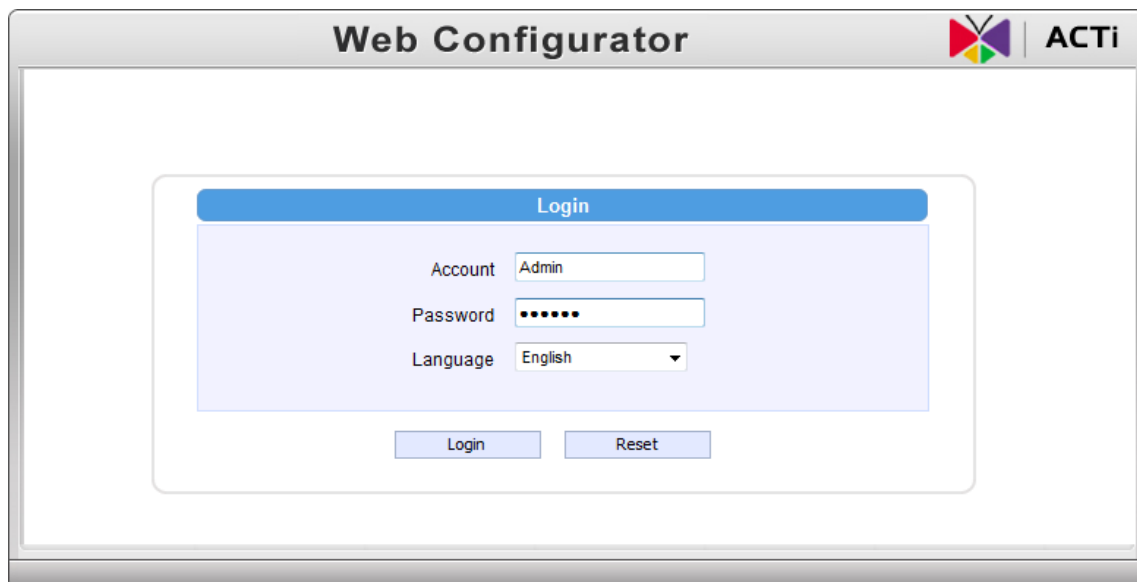

6. After logging in, you will see the video from camera. To go to the main menu, click the "Setup" button on the top left.

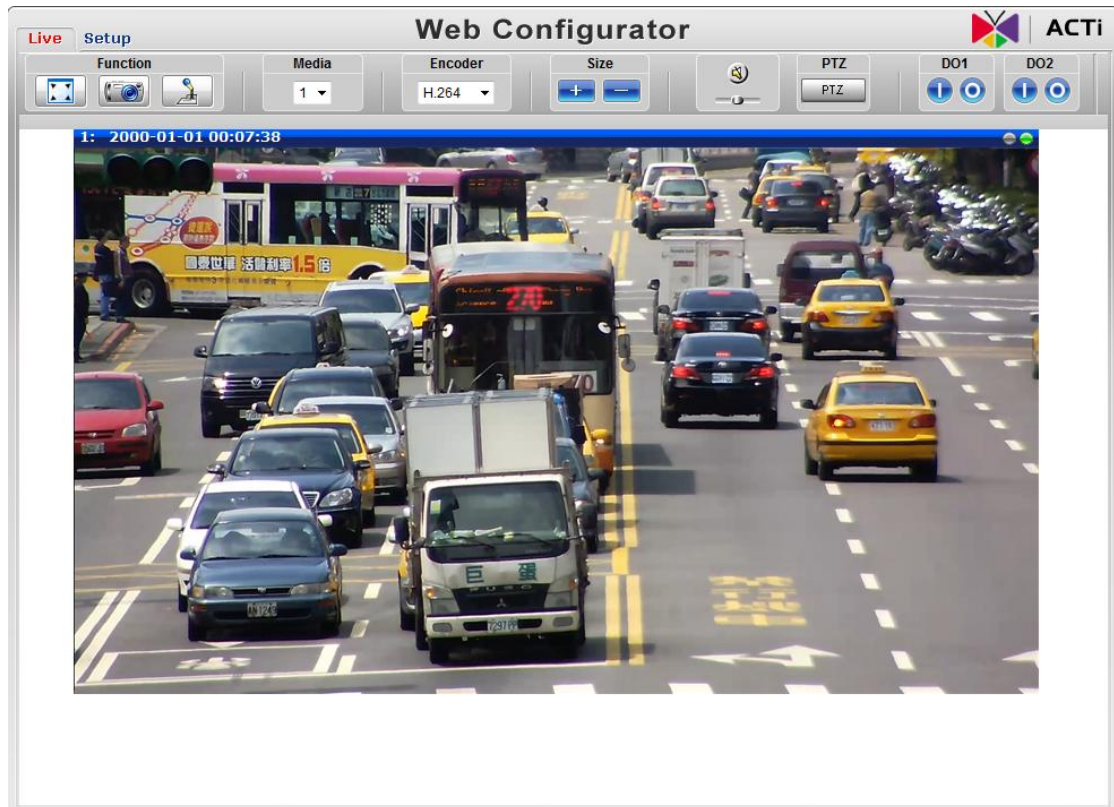

If you are using a single camera, this is enough to access the device.

If you are using multiple devices, you need to change the current device to another unused IP address, so that when the next device is connected to the network, no two devices use the same IP. Please perform the following steps.

7. Go to IP Settings-> Connection Type
8. Change the IP mode to Static.
9. Change the IP to 192.168.0.101 or any other unused IPs. Do NOT use the PC's IP address or 192.168.0.100.). If this is not the first device you add to the network, please also avoid other devices' IPs.

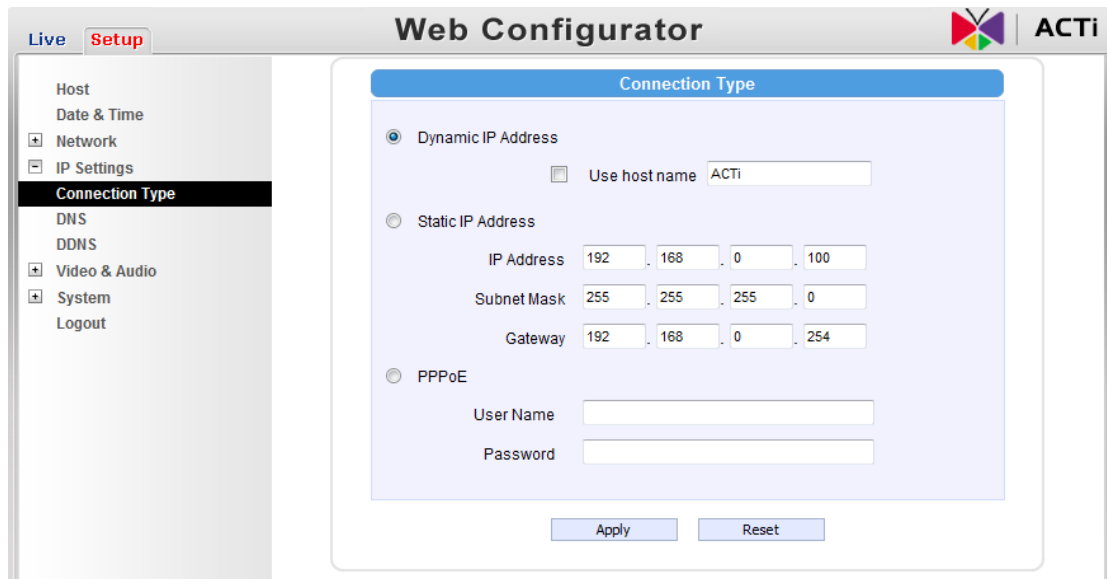

10. Click “Apply”

11. Please go to System -> Save & Reboot, and click “Apply”. Internet Explorer will close after a few seconds. This is normal.

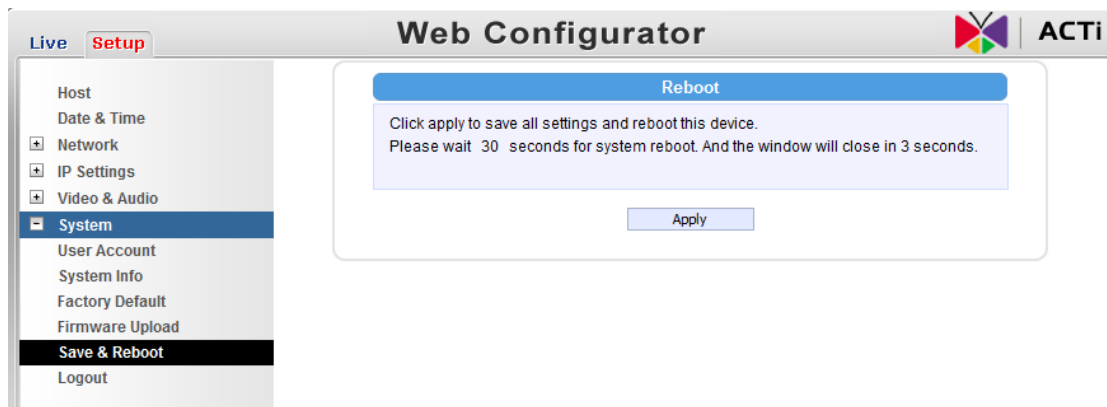

12. Wait for 30 seconds, and open IE again to connect to the **new IP**. (In this example, 192.168.0.101). For the second device or more you add into the network, please type the correct IP.

13. Adjust the default Video setting by going to Video & Audio -> Video Compression

Web Configurator  **ACTi**

Live **Setup**

- Host
- Date & Time
- Network
- IP Settings
- Video & Audio
- Stream Mode
- Video Compression**
- Motion
- Image
- Day/Night
- Exposure/White Balance
- Audio
- OSD/Privacy Mask
- System
- Logout

Video Compression

1: 2000-01-01 00:17:20



Encoder Type: H.264
Resolution: N1920x1080
Frame Rate: 15
Video Bit Rate Mode: Constant Bit Rate
Video Max Bit Rate: UNLIMITED
Video Bit Rate: 4M