

ACM-4201

Megapixel IP PoE Cube Camera with PIR Hardware User's Manual

(DC 12V / PoE)

Ver. 2012/3/12



Table of Contents

0. Precautions	3
<hr/>	
1. Introduction	4
<hr/>	
Package Contents	4
Features and Benefits	5
Safety Instructions	6
Physical description	8
Basic Connections	11
Product Specification.....	12
<hr/>	
2. Accessing Camera	13
<hr/>	
If you have DHCP server / router in your network:	13
If you do <i>NOT</i> have DHCP server / router in your network:	13

0. Precautions

Read these instructions

You should read all the safety and operating instructions before using this product.

Heed all warnings

You must adhere to all the warnings on the product and in the instruction manual. Failure to follow the safety instruction given may directly endanger people, cause damage to the system or to other equipment.

Servicing

Do not attempt to service this video device yourself as opening or removing covers may expose you to dangerous voltage or other hazards. Refer all servicing to qualified service personnel.

Trademarks

All names used in this manual are probably registered trademarks of respective companies.

Liability

Every reasonable care has been taken during the writing of this manual. Please inform your local office if you find any inaccuracies or omissions. We cannot be held responsible for any typographical or technical errors and reserve the right to make changes to the product and manuals without prior notice.

FCC/CE Regulation

NOTE: This equipment has been tested and found to comply with the limits for a Class A digital device, pursuant to Part 15 of the FCC Rules. These limits are designed to provide reasonable protection against harmful interference when the equipment is operated in a commercial environment. This equipment generates, uses, and can radiate radio frequency energy and, if not installed and used in accordance with the instruction manual, may cause harmful interference to radio communications. Operation of this equipment in a residential area is likely to cause harmful interference in which case the users will be required to correct the interference at their own expense.

1. Introduction

Package Contents

ACM-4201



Product CD



Camera Stand



Warranty Card

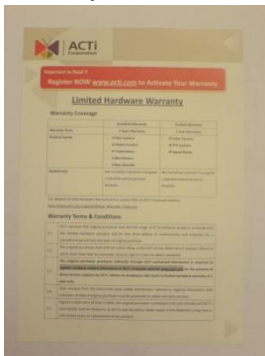

Accessories

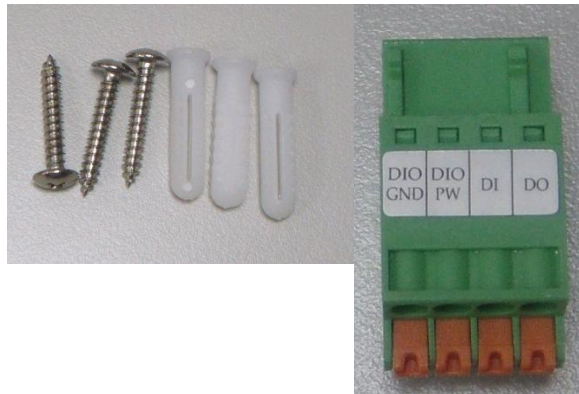

Features and Benefits

This is a cutting-edge digital video surveillance camera. It can compress and transmit real time images with outstanding image quality (8 FPS @ SXGA, 1280x1024) through a standard TCP/IP network. This camera is your best choice to build an intelligent IP surveillance system.

MPEG-4/MJPEG Dual Codec Compression

This device supports two compression formats, MPEG-4 and MJPEG. It brings superior image quality at 8 frames per second up to a resolution of SXGA (1280 x 1024) pixels, and offers up to 10 frames per second in HD720 (1280x720). In VGA (640 x 480) / QVGA / QQVGA the device reaches 30 frames per second.

Built-in Hardware Motion Detection

No more external motion sensors are required. You may assign up to 3 video motion detection areas. By tuning the object size and sensitivity, it will reliably detect objects passing through its view. Hardware motion detection also offers better sensitivity and faster response time than software motion detection.

Powerful Bundled Surveillance Software

To extend the capabilities of the IP Box Camera series, a powerful surveillance program is included in the package for free. Users can easily use an existing PC as a digital video recorder. Scheduled recording and manual recording keep every important video recorded in the local hard disk. Reliable and accurate motion detection with instant warning enables immediate response in every condition. Quick and simple search and playback function lets you easily find the images and video you want.

Software Development Kit Support

This IP Camera can be integrated or controlled by applications from third party software developers. Software developers can save considerable efforts by using our Streaming Library or ActiveX control. Please contact us for details on integration support.

Digital Time Code Embedded

The "Digital Time Code Embedded" function records video time in the video stream. Therefore, each image frame is marked with its original recording time. It is very useful when users want to find the video at an exact time or between a certain time intervals.

Safety Instructions

Don't use the power supply with other voltages

This device is likely to be damaged or damage other equipments / personnel, if you use a power supply with different voltage than the one included with this device. All warranty of this product will be voided in the situations above.

Don't open the housing of the product

Cleaning

Disconnect this video product from the power supply before cleaning.

Attachments

Do not use attachments not recommended by the video product manufacturer as they may cause hazards.

Water and Moisture

Do not use this video product near water, for example, near a bathtub, washbowl, kitchen sink, or laundry tub, in a wet basement, or near a swimming pool and the like.

Don't use accessories not recommended by the manufacturer

Only install this device and the power supply in a dry place protected from weather

Servicing

Do not attempt to service this video product yourself as opening or removing covers may expose you to dangerous voltage or other hazards. Refer all servicing to qualified service personnel.

Damage Requiring service

Disconnect this video product from the power supply immediately and refer servicing to qualified service personnel under the following conditions.

- 1) When the power-supply cord or plug is damaged
- 2) If liquid has been spilled, or objects have fallen into the video product.
- 3) If the video product has been directly exposed to rain or water.
- 4) If the video product does not operate normally by following the operating Instructions in this manual. Adjust only those controls that are covered by the instruction manual, as an

improper adjustment of other controls may result in damage, and will often require extensive work by a qualified technician to restore the video product to its normal operation.

Safety Check

Upon completion of any service or repairs to this video product, ask the service technician to perform safety checks to determine if the video product is in proper operating condition.

Physical description



1) Action LED Indicator

LED light will light up after the Camera has successfully completed the boot process.

2) Microphone Input

Sensitivity: $-36\text{dB} \pm 3\text{dB}$ (0dB=1V/Pa at 1KHz)

S/N Ratio: More than 58dB

Directivity: Omni directional

3) Motion Sensor (PIR) *

Motion Sensor detects movement by looking at changes in the Infrared (IR) spectrum.



* Available only for device versions with enhancements

4) Audio Output

The IP device supports audio output with earphone jack

5) Ethernet Port

The IP device connects to the Ethernet via a standard RJ45 connector. Supporting NWAY, this IP device can auto detect the speed of local network segment (10Base-T/100Base-TX Ethernet).

6) DV 12V Power Input

Connect the power adaptor here if your power input is DC12V.

7) Digital Input / Output *

Used in applications like motion detection, event triggering, time lapse recording, alarm notifications, etc., the I/O terminal connector provides the interface to:

• **1 Digital Input** - An alarm input for connecting devices that can toggle between an open and closed circuit, for example: PIRs, door/window contacts, glass break detectors, etc. The device will detect the change in digital input and transmit the signal to video surveillance servers.

Connect pins 1 and 3 to your Digital Input device.

• **1 transistor output** - For connecting external devices such as relays and LEDs. Connected devices can be activated by Output buttons on the Live View page or through video management software. **Connect pins 2 and 4 to your Digital Output device.**

The I/O terminal pins are numbered left to right

Pin 1	GND	Ground	Description
Pin 2	12V (Digital Output Power Side)	This pin provides DC 12V power which can be connected to Pin 4 via DO devices to complete a DO circuit with a maximum current of 100mA.	Voltage: 12V DC, Max: 1.2W
Pin 3	Digital Input	Connect to GND to activate, or leave floating (or unconnected) to deactivate.	Must not be exposed to voltages greater than 30V DC.
Pin 4	Transistor Output	Uses an open-collector NPN transistor switch that connects to the internal ground to complete the circuit with Pin 2. If used with an external relay, a diode must be connected in parallel with the load for protection against transient voltages.	Max load = <100mA Max voltage = 24V DC (to the transistor)

* Available only for device versions with enhancements

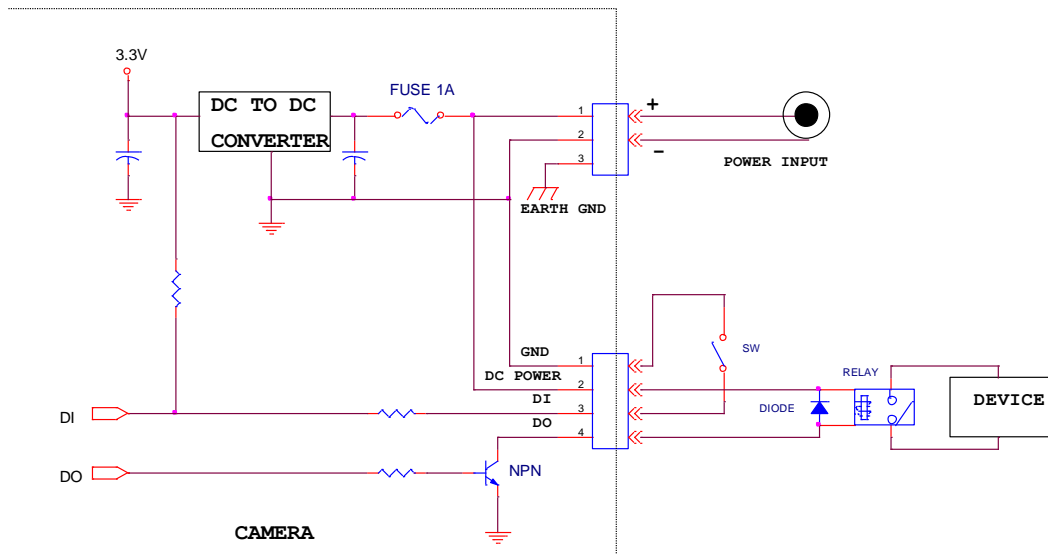

Connect input/output devices to the camera as follows:

1. Attach the cables for the device securely to the supplied green connector block.
2. Once the cables are connected, push the connector block into the terminal connector (also green) on the camera.

8) Reset Button

Step 1: Switch off IP device by disconnecting the power cable

Step 2: Press and continue to hold the Reset Button (with a sharp tipped object, like a pen.)

Step 3: **Reconnect the power cable while continuing to hold the reset button.** The Power LED light will flash on for 3 second first, turn off for about 15 seconds, flash on for another second and turn off again. By this time the reset to default operation is already completed.

This will take around 20 seconds from power up. You may then release the reset button.

This length of time fluctuates slightly with the environment. The Power LED light will come back on and stay on after a few more seconds. The unit will start up with factory default settings automatically.

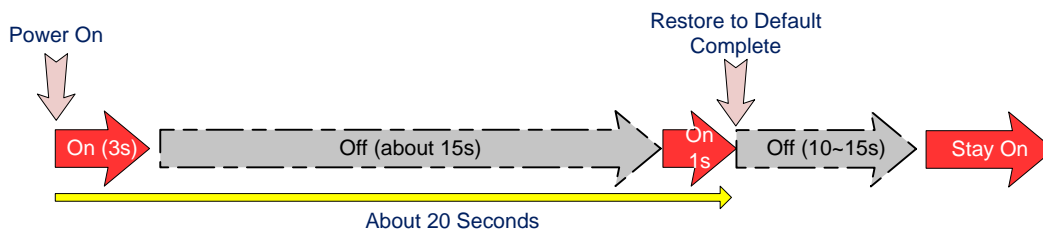

Basic Connections

Follow the procedures below to connect the IP device to the respective apparatuses.

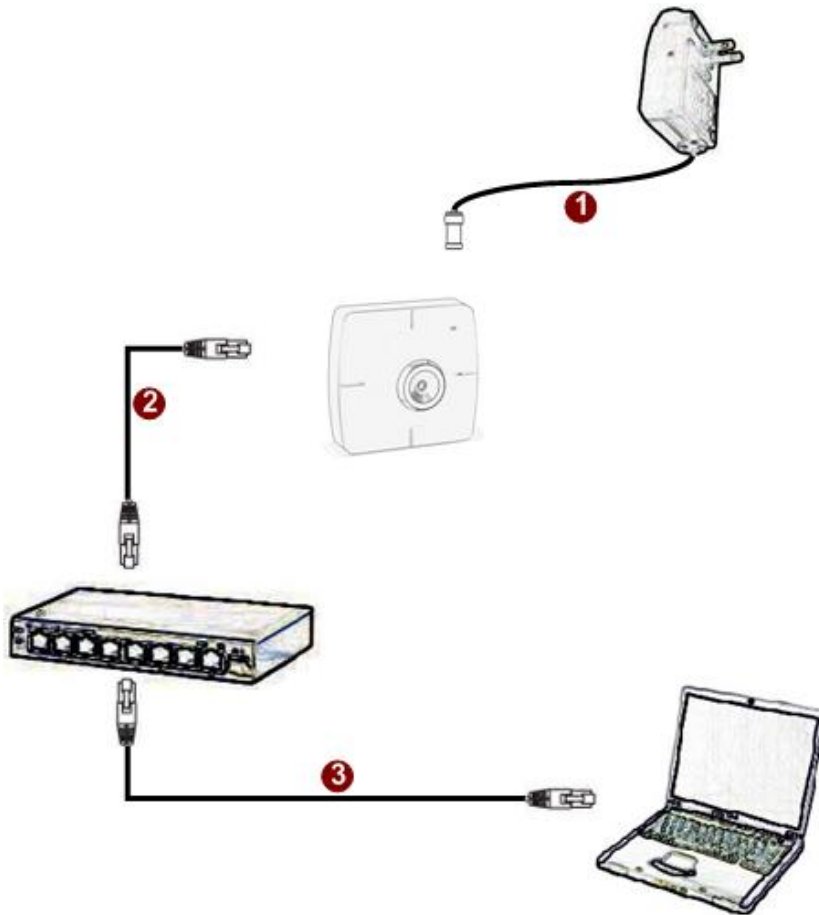

If you have a PoE (Power over Ethernet) supported switch or injector: (PoE Enabled version only)

- 1) Connect your IP Camera to the Switch / Injector by CAT5 or CAT6 cables with RJ45 connector.
- 2) Connect your Switch / Injector to PC with another CAT5 / CAT6 network cable.

If your switch does not support PoE, and you are powering the camera with power adaptor:

- 1) Connect the power adaptor to IP Camera
 - 2) Connect IP device's Ethernet port to Network switch (via RJ45 connectors).
- Connect a PC to the Ethernet switch (via RJ45 connectors)

Please refer our [PoE Guide](#) for more details on Power over Ethernet related concepts.

Product Specification

		ACM-4201	
Image	Device	Micron Progressive Scan CMOS	
	Size	1/3 inch	
	Effective Pixels	1280(H) x 1024(V)	
Min. scene Illumination	Color	0.5 Lux at F1.0 (2400°K, 30 IRE)	
Lens	Lens	f4.2mm / F1.8	
	Viewing Angle	75° (Horizontal)	
Synchronization	Sync. System	Internal	
Functions	Motion Detection	Yes (3 Windows)	
	Electronic shutter	1/5 ~ 1/15,000 sec.	
	Fixed Shutter (Manual)	1/30 ~ 1/1,000 sec. (60Hz)	
		1/25 ~ 1/1,000 sec. (50Hz)	
	Flickerless	1/120 sec. (60Hz) 1/100 sec. (50Hz)	
	BLC	Yes	
	AGC	Automatic (User defined)	
White Balance	AUTO, INDOOR1, INDOOR2, OUTDOOR1, OUTDOOR2, HOLD CURRENT, MANUAL		
S/N Ratio	S/N Ratio	Better than 44 dB	
Video Compression	Compression	MPEG-4 SP / MJPEG Selectable	
	Picture Resolution	SXGA (1280 x 1024) HD 720 (1280 x 720) VGA (640 x 480) QVGA(320 x 240) QQVGA(160 x 112)	
		Bit Rate	28K ~3M bps
		Image Frame Rate	SXGA at 8 fps HD720 at 10 fps VGA at 30 fps QVGA at 30 fps QQVGA at 30 fps
Audio Input	Compression	8kHz, Mono, PCM	
	Built-in Microphone	Sensitivity: -36±3dB(0dB=1V/Pa); S/N Ratio: more than 58dB; Directivity: Omni-directional	
Audio Output	Compression	8kHz, Mono, PCM	
	Audio Line Output	Unbalanced, 1.4Vp-p, 1Vrms, 3.5mm Phone Jack	
Alarm	Digital Input	1, TTL, terminal block *	
	Digital Output	1, TTL, terminal block *	
	PIR sensor	Yes *	
External I/O	Reset Button	Factory Default	
	LED	System Status	
Network	Ethernet	Ethernet(10/100 Base-T), RJ45 Connector	
	Protocol	TCP, UDP, IP, HTTP, HTTPS, DHCP, PPPoE, RTP, RTSP, FTP, SMTP, DNS, DDNS, NTP, ICMP, IGMP, ARP, UPnP	
Software	Web Browser	Microsoft Internet Explorer 6.0 or above	
	SDK	ACTi SDK-10000	
	Security	Password Protection: Configured by the administrator	
Operating	Temperature	-10°C ~50°C (14°F ~ 122°F)	
Power	Power Requirement	PoE (IEEE 802.3af) with Class 3	
	Power Consumption	DC 12V 2.88W / PoE 4.32W	
Physical	Dimensions (WxHxD)	88 mm x 85 mm x 39 mm (3.46" x 3.35" x 1.54")	
	Weight	150g (0.33 lb) (w/o bracket)	

* Available only for device versions with enhancements

2. Accessing Camera

If you have DHCP server / router in your network:

Many network server / routers are able to automatically provide IP addresses through DHCP. If you are using such a network, just plug in your computer and IP Camera into the network and your IP device will acquire network address by itself. Find and access the device with our IP Utility program. You may download it at:

[http://www.acti.com/product/detail/Software/ACTi Utility Suite](http://www.acti.com/product/detail/Software/ACTi_Utility_Suite)

If you do **NOT** have DHCP server / router in your network:

1. Configure your PC to use the same subnet by changing your PC's IP address to the subnet with prefix 192.168.0.XXX. The last number should be anything from 1 to 254 except 100 and other occupied IP addresses. Subnet mask should be 255.255.255.0.
2. **The default IP used by this device is 192.168.0.100. Please make sure your PC is NOT using this address and that no two equipments use the same IP address in the network.**
3. Change your IP address by going to Control Panel ->Manage Network Connections -> Right click on the connection to change -> Option -> TCP/IP IPv4 Properties.

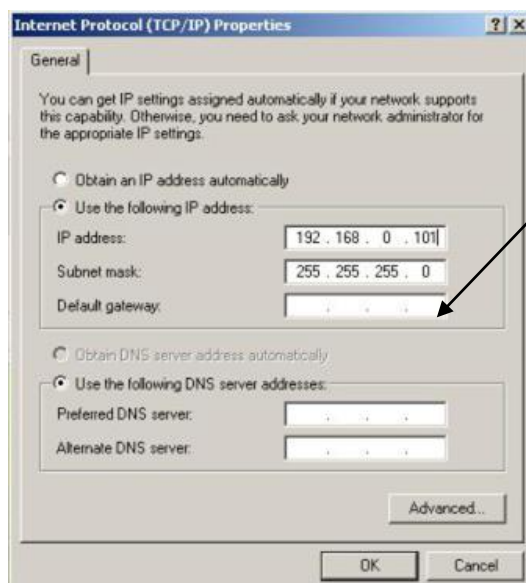

Please set the settings as below.

-
- IP address: 192.168. 0.xxx
- Subnet mask: 255.255.255.0

(NOTE: xxx should be a number from 1 to 254 except 100, which is used by the IP device. Please also make sure that no two equipments use the same IP address in the same network.)

4. Open Internet Explorer (Version 6.0 or above) , and type in the Default IP:
192.168.0.100
5. When you see the login window, please input default user and password:
Default User: Admin Password: 123456

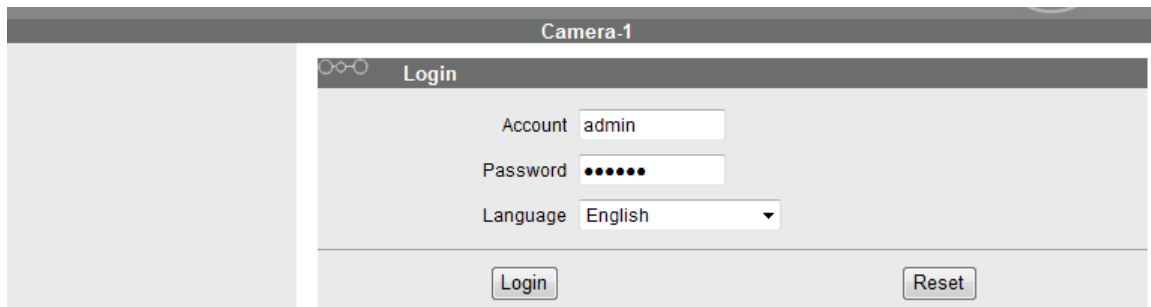

6. After logging in, you will see the video from camera. To go to the main menu, click the "Setup" button on the top left.

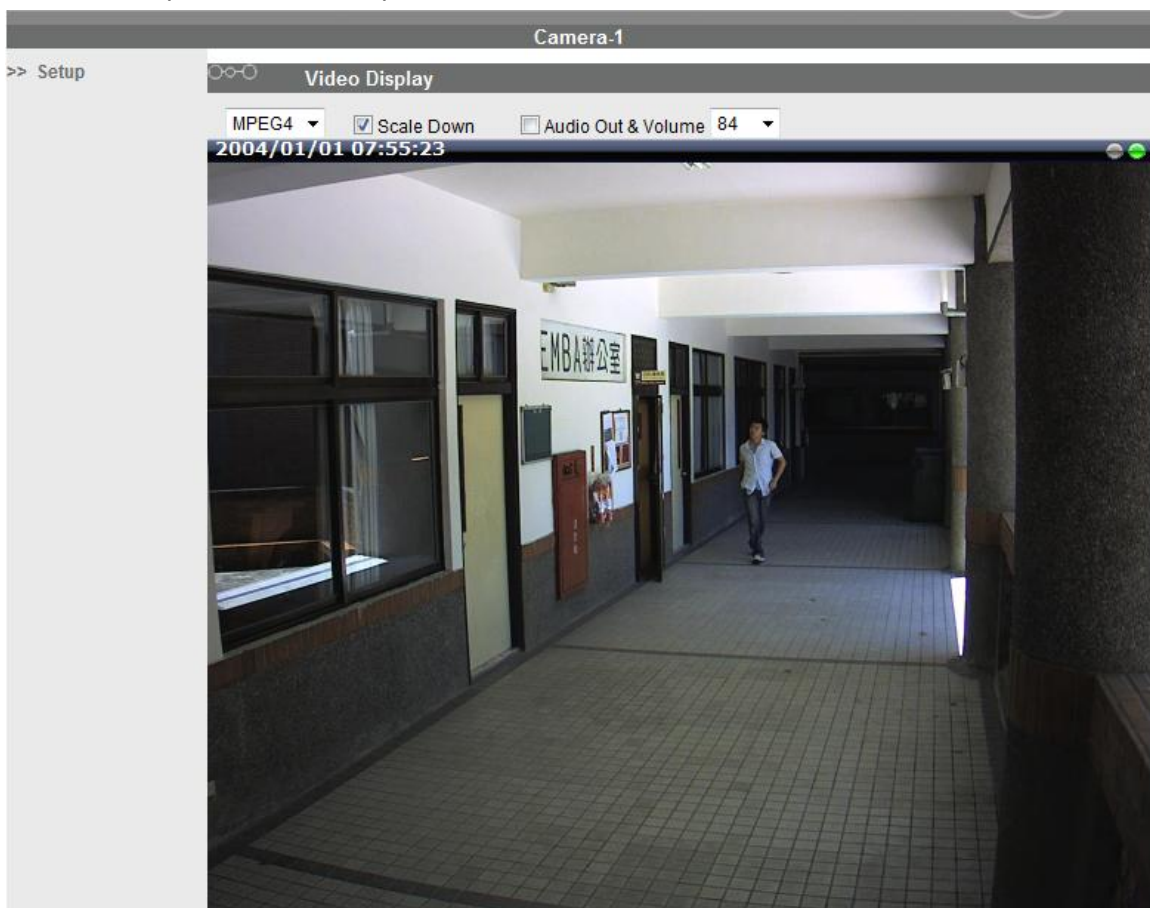

If you are using a single camera, this is enough to access the device.

If you are using multiple devices, you need to change the current device to another unused IP address, so that when the next device is connected to the network, no two devices use the same IP. Please perform the following steps.

7. Go to Setup -> WAN Setting
8. Choose Static IP Address.
9. Change the IP to 192.168.0.101 or any other unused IPs. Do NOT use the PC's IP address or 192.168.0.100.). If this is not the first device you add to the network, please also avoid other devices' IPs.

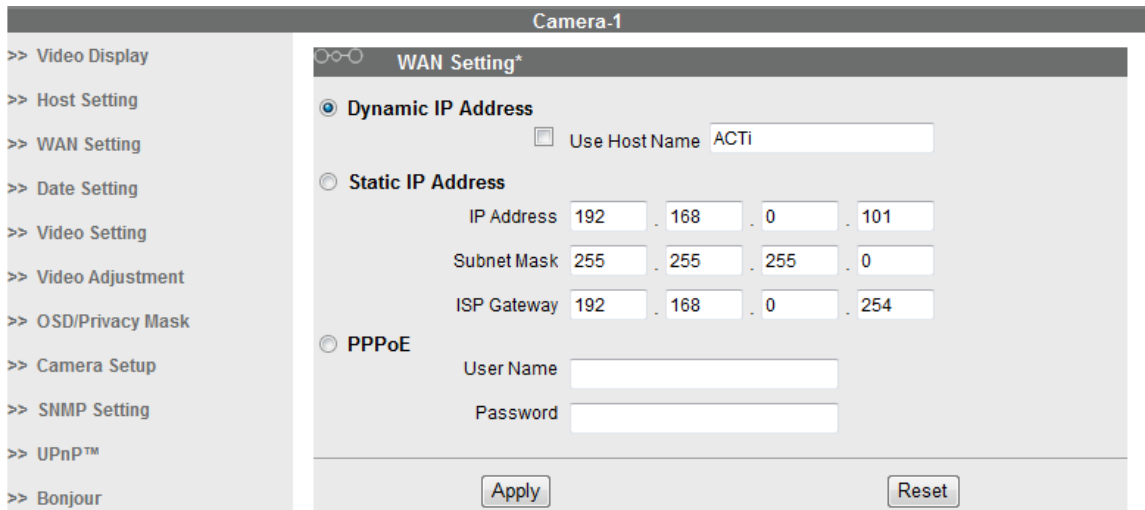

10. Click "Apply"
11. Please go to Save Reboot, and click "Apply". Internet Explorer will close after a few seconds. This is normal.

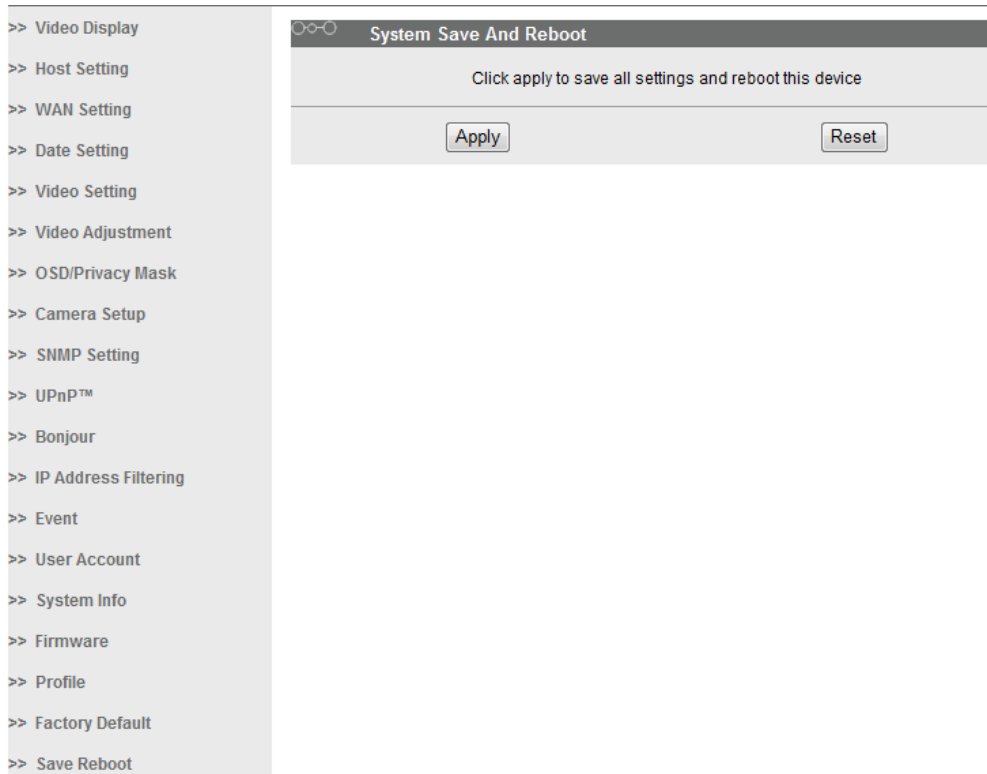

12. Wait for 30 seconds, and open IE again to connect to the **new IP**. (In this example, 192.168.0.101). For the second device or more you add into the network, please type the correct IP.

13. Adjust the video stream by going to Video Setting

