

ACM-3011

IP IR D/N PoE Fixed Dome



- 1/3" Aptina Progressive Scan CMOS
- Day and night function with mechanical IR cut filter
- Minimum illumination 0 lux with IR LED on
- Built-in 3.3-12 mm / F1.6 vari-focal lens
- 30 fps at 640 x 480 resolution
- Selectable MPEG-4 SP, MJPEG compressions
- Two-way audio
- Video motion detection
- Powered by PoE Class 3 / DC 12V

PHOTO INDICATION

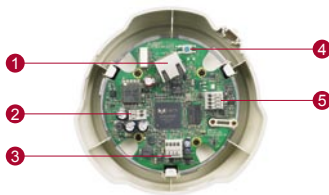

- ① Ethernet port
- ② DC 12V Power Input
- ③ Audio Input / Output
- ④ Reset button
- ⑤ Digital Input / Output



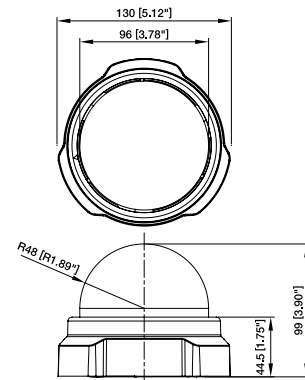

DIMENSION DIAGRAM



Unit: mm [inch]

ACCESSORY OPTIONS

Dome Cover		
PDCX-0100		3-inch, smoke, non-vandal proof

Popular Mounting Solutions		
Surface	Accessories not required	
Wall	PMAX-0308 	
Pendant	PMAX-0101 + PMAX-0103 	
Corner	PMAX-0101 + PMAX-0303 + PMAX-0402 	
Pole	PMAX-0101 + PMAX-0303 + PMAX-0502 	
Flush	PMAX-1006 	

* For more mounting solutions, please refer to Mounting Accessory section of Buyer's Guide or Project Planner v2.0 on www.acti.com

PRODUCT SPECIFICATION**ACM-3011****• Device**

Device Type	Fixed Dome Camera
Image Sensor	Aptina Progressive Scan CMOS
Sensor Size	1/3" (4.8 x 3.6 mm)
Day / Night	Yes
Minimum Illumination	Color: 0.5 lux at F1.0 (2400 °K, 30 IRE); B/W: 0 lux (IR LED on)
Color to B/W switch	CDS sensor based switch
Mechanical IR Cut Filter	Yes
IR Sensitivity Range	700 nm - 1100 nm
IR LED	IR LED x 24 (850 nm)
IR Working Distance	30 m (0 lux, 30 IRE, Max Exposure Gain)
Electronic Shutter	1/30 - 1/1,000 sec (60 Hz); 1/25 - 1/1,000 sec (50 Hz) (manual mode) 1/5 - 1/15,000 sec (auto mode)

• Lens

Focal Length	Vari-focal, f3.3 - 12 mm / F1.6
Iris	Fixed iris
Focus	Manual focus
Horizontal Viewing Angle	75.4° - 22.7°
Viewing Angle Adjustment	Pan: 0° - 330°; Tilt: 30° - 90°

• Video

Compression	MPEG-4 SP, MJPEG
Maximum Frame Rate vs. Resolution	30 fps at 640 x 480 (VGA); 30 fps at 320 x 240 (QVGA); 30 fps at 160 x 112 (QQVGA)
Multi-Streaming	Multiple streams based on single configuration
Bit Rate	28Kbps - 3Mbps (per stream)
Bit Rate Mode	Constant, Variable
S/N Ratio	More than 44 dB
Image Enhancement	White balance: automatic, predefined and manual; Brightness; Saturation; Contrast; Sharpness; Automatic gain control; Auto exposure: automatic, predefined and manual; Flickerless
Privacy Mask	1 configurable region
Text Overlay	User defined text on video
Image Orientation	Image flip and mirror

• Audio

Compression	8 kHz, Mono, PCM, 16 bit encoding
Audio-In	Terminal block
Audio-Out	Terminal block

• Network

Protocol & Service	TCP, UDP, HTTP, HTTPS, DHCP, PPPoE, RTP, RTSP, DNS, DDNS, NTP, ICMP, ARP, IGMP, SMTP, FTP, UPnP, SNMP, Bonjour
Ethernet Port	1, Ethernet (10/100 Base-T), RJ-45 connector
Security	IP address filtering; HTTPS encryption; Password protected user levels

• Alarm

Alarm Trigger	Video motion detection (3 regions); External device through digital input
Alarm Response	Notify control center; Change camera settings; Command other devices; E-mail notification with snapshots; Upload video, snapshot to FTP server; Activate external device through digital output

• Interface

Digital Input	1, TTL, terminal block
Digital Output	1, TTL, terminal block

• General

Power Source / Consumption	PoE Class 3 (IEEE802.3af) / 6.8 W DC 12V / 5.0 W
Weight	380 g (0.84 lb)
Dimensions (Ø x H)	130 mm x 99 mm (5.12" x 3.90")
Mount Type	Surface, Flush, Wall, Pendant, Pole, Corner
Operating Temperature	-10 °C ~ 50 °C (14 °F ~ 122 °F)
Approvals	CE, FCC

• Integration

Unified Solution	Fully compatible with ACTi software
ISV Integration	Software Development Kit (SDK) available
Firmware Access Browser	Microsoft Internet Explorer 6.0 or newer

* All specifications are subject to change without notice.

* All brand names and registered trademarks are the property of their respective owners.

www.acti.com